

Not only is it important to select the correct seat, but also to fix it in the chair in the correct position. The adjustable bracket (C) offers a choice of six different positions. The bracket (C) is fitted to all Flemming Chairs as standard.

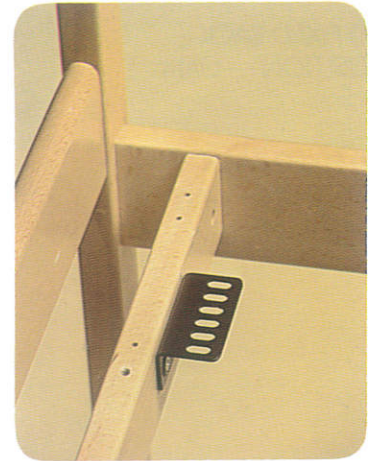

31

**(4) — SPLIT BACK WITH WINGS.** This has the same benefit as (3), with the additional advantage of wings.



34

**(5) — HIGH BACK WITH FIXED WINGS.** Here the back is shown with the adjustable neck pillow (L).



35

**(O) — BODY SUPPORT** supplied with back strap, adjustable both in width and up and down the back of the chair.



38

**(D) — TOWELLING SEAT COVER** — used in conjunction with incontinence pad.



39

**ARM HEIGHT.** Should arm height need reducing between arm and top of cushion. Two cushion bearer rails are now available. One at 2.5cm and one at 5cm.

Now available separate fully adjustable inflatable lumbar support.



**(1350) STOOL** — can be made to match any of the Flemming chairs and is supplied in the same wood finishes and fabrics.



42



**(A) FIXED BACK POSITION** — slight recline.

**(B) FIXED BACK POSITION** — very upright.



43

**(S) RECLINING BACK** — ELECTRICALLY OPERATED, moves from upright to full recline. Release the light pressure on the control button to stop the back in any position.

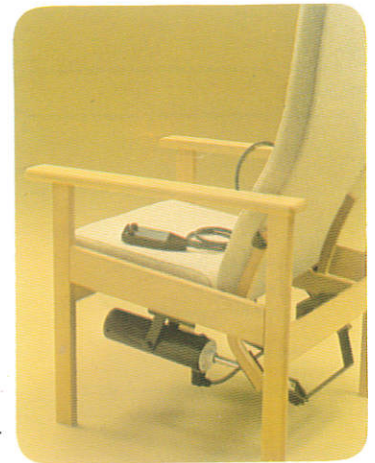

44

**(V) MANUALLY ADJUSTABLE SEAT RAKE** — easily adjusted to give three different angles to the seat. This fitting can be reversed to produce a forward sloping seat.



47

**(X1) SPRING OPERATED SEAT LIFT** — with this action the seat lift rises vertically keeping the seat almost horizontal.

**(W1)** As above but operated electrically.

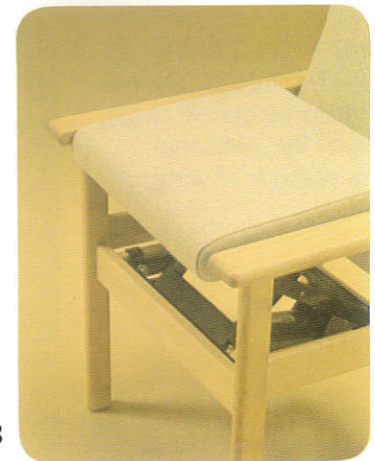

48

**(Y) LEG REST MOTORISED** — when the motor is linked to the back **(SY)** the result is a combined rising of the leg-rest and reclining back. Without a motor the same result can be achieved manually **(TY)** by putting slight pressure on the back and pushing with the arms.

51



**(Z) FOOT REST** — recommended for wheeled chairs. It is adjustable for height and can be folded away when not in use.

52



**CASTORS No. 5.** 5cm diameter castors. These can be fitted to the back legs to allow the empty chair to be easily moved for cleaning.

55

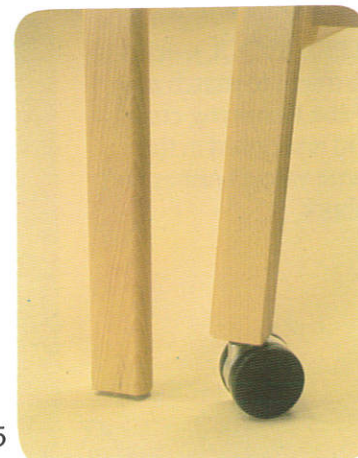

**CASTORS No. 8 and 12.** 8cm and 12cm diameter castors. These are normally supplied with fixed castors on the front legs and swivel castors on the back legs. The back swivel castors can be fitted with brakes for safety.

56

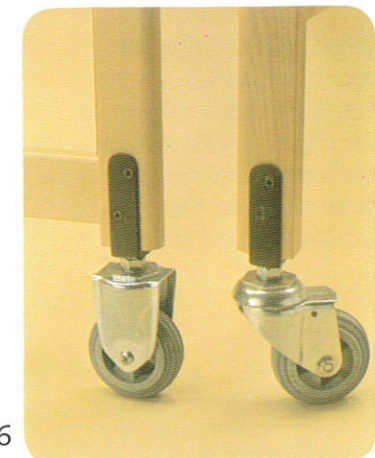



**(T) RECLINING BACK — MANUALLY OPERATED.** Release the hand brake which can be located under either arm, light pressure on the back, then adjust to any position from upright to full recline. (No hand brake when TY is fitted).

45

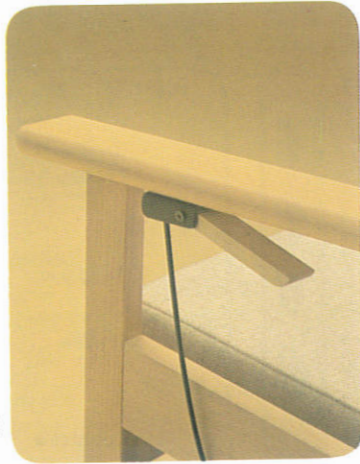

**(U) MANUALLY ADJUSTABLE BACK RAKE —** a simply operated hand ratchet behind the back allows the patient to select any of 4 positions including (A) and (B).

46



**(X2) SPRING OPERATED SEAT LIFT** — with this action, the seat lift rises and inclines.

**(W2)** As above but operated electrically.

49



**(X3) SPRING OPERATED SEAT LIFT** — with this action, the seat lift has little rise and substantial incline.

**(W3)** As above but operated electrically.

50



**(W1/2/3) HIGH PRECISION MOTOR CONTROL** for seat action — all mechanical and electrical parts are guaranteed for one year. Easily adjusted to any of 3 positions (see fig. 46, 47, 48).

53

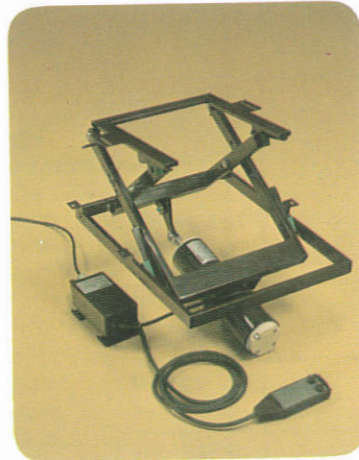

**HAND CONTROL** — there is no electricity in the easy hand control. It works on compressed air and is therefore completely safe. The motor will stop when the button is released.

54



To fix seat angle permanently in the mid or the high slope position there are two wedges available to fit in fix position C bracket.

It is recommended to have the angled fixed seat with reclining mechanisms S.TY.SY.T.

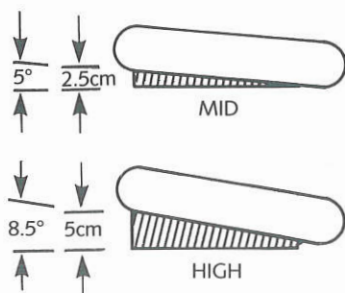

The measurements below the chair seat will be to the user's own assessment. See diagram (in centimetres) showing all measurements above the seat.

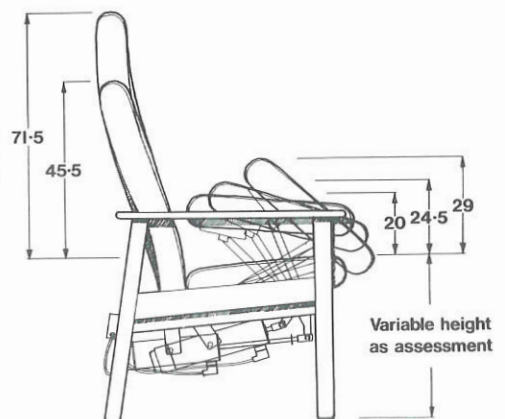

# Parker Care Components of the chair system

## FRAMES

PC131 Chair



PC132 Removable arm

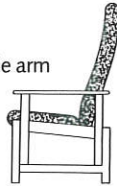

PC133 Seat, back and arm lift



PC134 Seat and arm lift



PC1350 Stool



PC138 Stand up chair

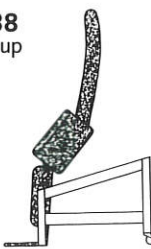

PC1360 Tray (not with P)

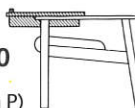

PC1361 Tray (use with P)

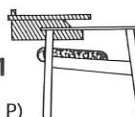

PC1370 Pivoting tray

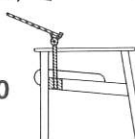

## BACKS

1 High back



2 Low back



3 Split back



4 Split back with wings



5 High back with wings



6 Extended split back



7 Extended split back with wings



## SEATS

F Std seat



FH Soft L.H.S



FJ Soft R.H.S



FK Soft front



Cut out FK – reversed soft front



G Std short seat



GH Soft L.H.S



GJ Soft R.H.S



GK Soft front



Cut out GK – reversed soft front



LONG Long seat



LONG H Soft L.H.S



LONG J Soft R.H.S



LONG K Soft front



Cut out LONG K – reversed soft front



## ELEMENTS

L Neck pillow for wing chair



LD Double size



M Neck pillow



MD Double size



N Head pillow supports



O Body supports



P Upholstered arms



AP Arm pads



D Seat cover



E Side support



LS Lumber support



Bearer rails

5cm



2.5cm



Seat wedge high mid



Magnetic control holder



Pushing handles



## FUNCTIONS



C Fixed seat



Seat lift  
W1 motor  
X1 spring

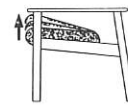

V Adjustable



W2 motor  
X2 spring

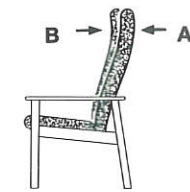

A Fixed back – slight recline  
B Fixed back – very upright



W3 motor  
X3 spring

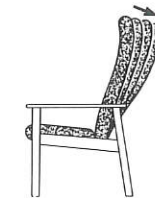

U Adjustable back

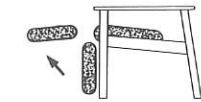

Y Rising leg rest – motor

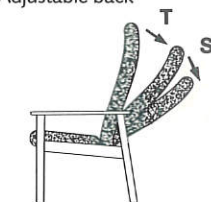

Reclining back  
S motor  
T gas strut

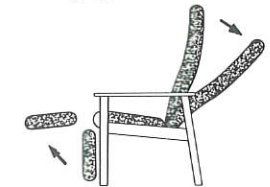

Combined back recline and leg rest  
SY motor  
TY gas strut

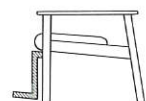

Z Adjustable foot rest for wheeled chairs

## WHEELS AND CASTORS

No. 5 5cm diameter. Swivel. Not to be used for moving occupied chairs

No. 8s 8cm diameter. Swivel  
No. 8sb 8cm diameter. Swivel with brake

No. 8f 8cm diameter. Non-swivel

No. 12s 12cm diameter. Swivel  
No. 12sb 12cm diameter. Swivel with brake

No. 12f 12cm diameter. Non-swivel



### Frame and functions combinations

To check the feasibility and minimum seat height of any frame combined with any function, follow the column across from the required frame to the vertical column under the function needed.

The number at the intersection is the minimum possible seat height — in centimetres. Check all functions needed. The highest number encountered will be the minimum possible seat height for the complete chair.

If the space at the intersection is shaded it indicates that that particular combination is not possible.

\*T can be used only if one arm is removable.

Functions See pages 9-10	Fixed back		Reclining back S motor T MANUAL Adjustable back U	Adjustable seat rake V	Seat lifts W1 motor X2 spring W3 motor X3 spring	Rising leg rest Y motor	Combined back recline and leg rest SY motor TY MANUAL	Adjustable foot rest for wheeled chairs Z
	A + B	C						
<b>PC131</b>	24	42	20	25	37	44	43	43 With 8cm castors
<b>PC132</b> Removable arm	42	*42 not T *See note		42	37 not X	44	43	43 With 8cm castors
<b>PC133</b> Seat, back and arm lift	37		37		38 not W3 or X3	43		43 With 8cm castors
<b>PC134</b> Seat and arm lift		42			42	44	43	43 With 8cm castors
<b>PC1350</b> Stool	27			31				

### Wheels and castors – limitations

To check the feasibility and minimum seat height when specifying the castors or wheels, follow the column across from the proposed wheel or castor to the vertical column under the diagram of the required frame and functions combination. If any function required is not shown, the limitations will be the same as for the frame with no special functions.

The number at the intersection is the minimum possible seat height in centimetres. Check all frame and functions combinations needed. The highest number encountered will be the minimum possible seat height.

If the space at the intersection is shaded, it indicates that that particular wheel or castor cannot be used.

8 and 12cm castors are normally used in sets of 4 to make a chair mobile. If people are to be wheeled in a chair, pushing handles "R" and footrest "Z" should normally be used.

Electrically operated functions would not usually be used in conjunction with these larger wheels and castors.

Frame and functions combinations See page 9	Wheels and castors See page 9	PC131 + A+C + B	PC131 + S or T	PC131 + Y	PC132 + S or T	PC132 + Y	PC133 + PC134	PC134 + Y
		<b>No. 5</b> 5cm swivel. Not for moving occupied chairs		27	42	44	42	44
<b>No. 8s</b> 8cm swivel*		43	43	44	48	48	48	48
<b>No. 8sb</b> 8cm swivel with brake †		47	44 fix b 43, 48	44	48	48	48	48
<b>No. 8f</b> 8cm non-swivel		43	43	44	48	48	48	48
<b>No. 12s</b> 12cm swivel*		47	47	47				
<b>No. 12sb</b> 12cm swivel with brake †		47	47	47				
<b>No. 12f</b> 12cm non-swivel		47	47	47				

\*Swivel castors should not normally be used on all four legs because it makes the chair more difficult to control.

† Castors with a brake should normally be used on the back legs to make the brakes more accessible when pushing the chair.





**Parker Care**

PO Box 22  
Frogmoor  
High Wycombe  
Bucks HP13 5DJ  
Telephone: High Wycombe (0494) 21144



Sales Forecast.

47 weeks

	units	Revenue Price	
Mult 3	1	750	35 250
	4	847	79 618
	5	847	119 427
	<u>6</u>	<u>995.</u>	<u>467 650</u>
Black Maltin.	16	—	<u>701,945</u>
		522	171,738
131 + V.	7	<del>508</del>	167,132
131	<u>13</u>	<u>194</u>	<u>118,534</u>
Tot 131	20	—	+ 4 666 <u>285 666</u>

26

1990 - 1991.

3 Quarte 1991  
 Feb. - May. APRIL =  
 last Quarter of 1991 =  
 MAY JUNE JULY

(1222 units) 24 606  
 + 987,611  
1 500,000.

246,903.

1991 - 1992

1<sup>st</sup> Quarter  
 2<sup>nd</sup> "  
 3<sup>rd</sup> "  
 4<sup>th</sup> "

247 000  
 260,000  
 270 000  
 283,000  
1 060,000



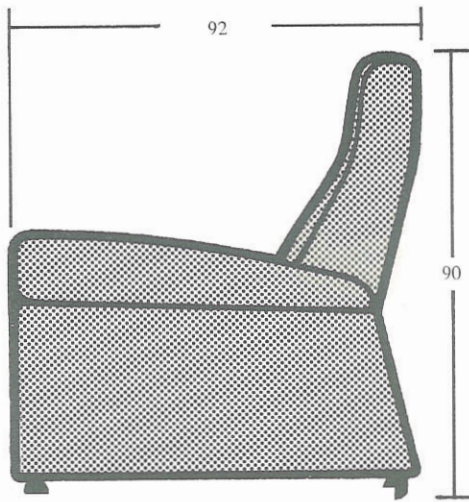

Chair Closed

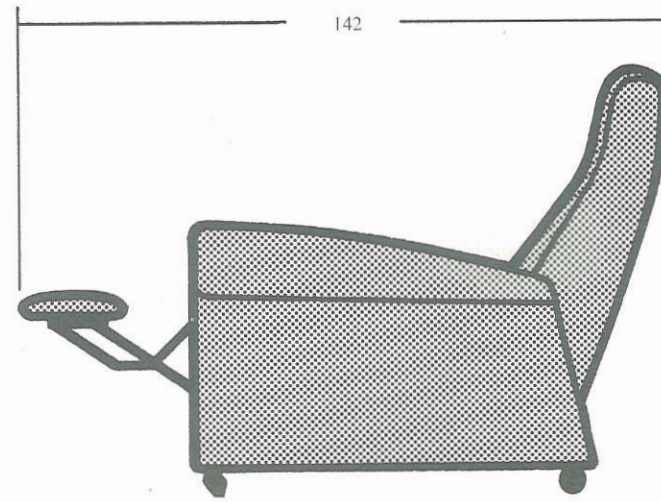

Semi Recline

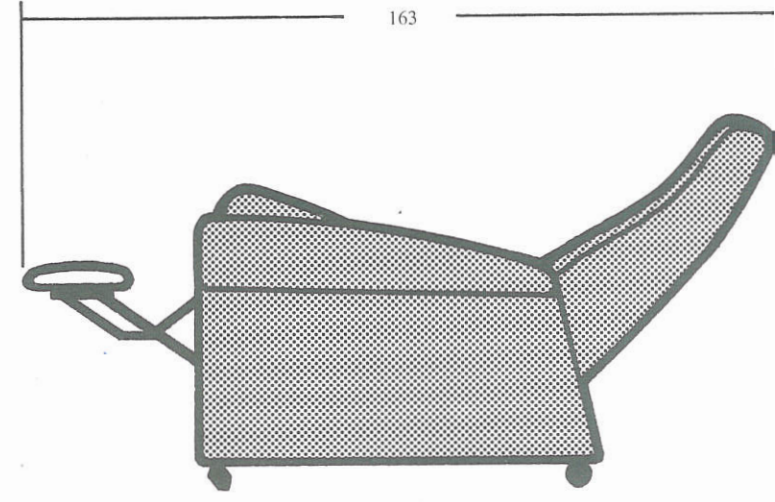

Full Recline

Parker Knoll Contracts reserve the right to alter prices and specifications without notice



The Nimrod Recliner with its special protective apron is aimed specifically at the Health Service and is widely used in many hospital locations :-  
Dialysis units, Day-care centres, Post-operative care, Maternity units and Neuro-Surgical wards.



Parker Knoll Contracts

# Nimrod Recliner

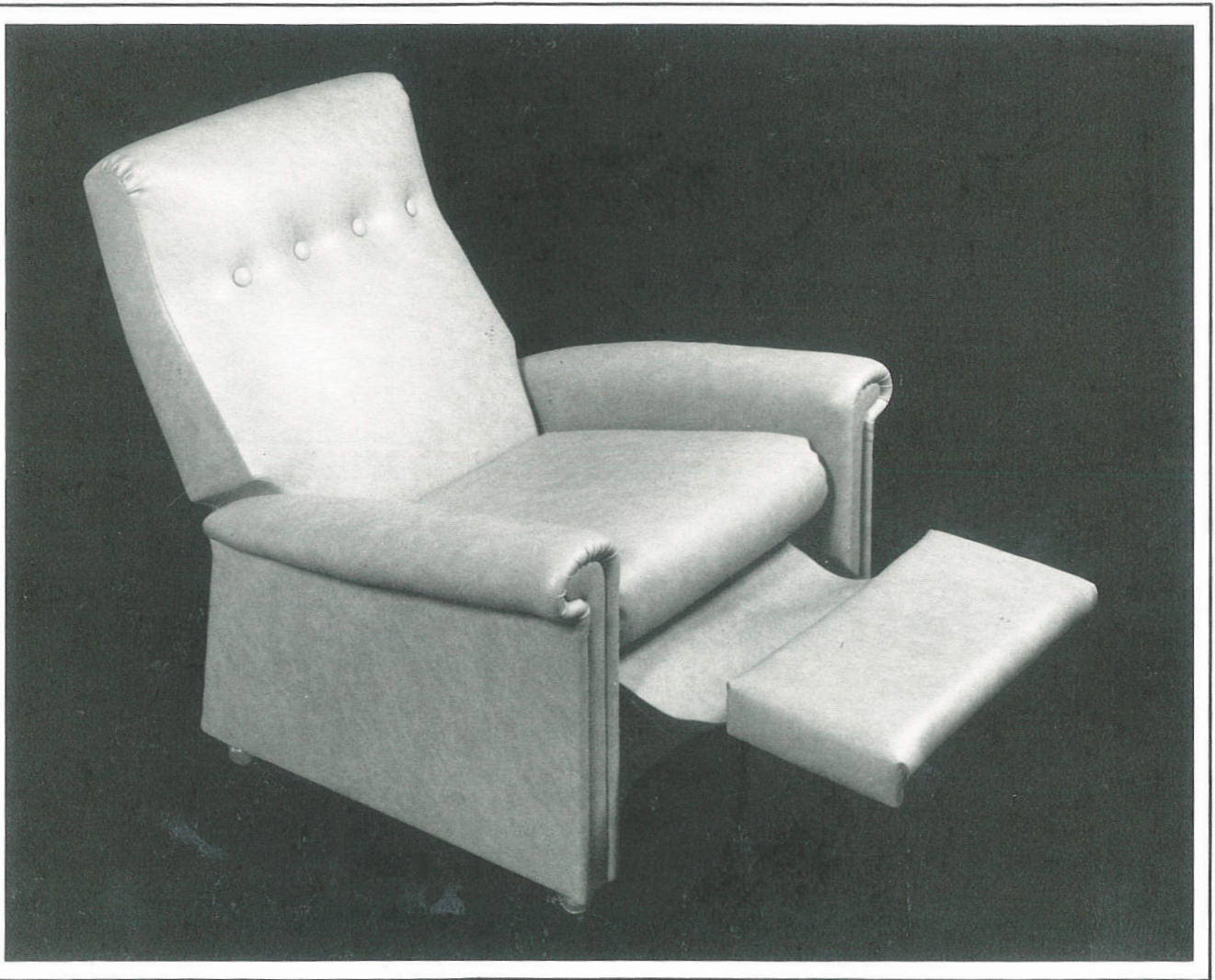

MODEL No. N116

- ★ Widely used in hospital locations.
- ★ Three positions - upright, semi-recline, full recline.
- ★ Simple, reliable and easily manipulated action.
- ★ Compact uncluttered design.
- ★ Fire retardant to DOE/PSA Standard for F/R chairs FR6 (IG source 0, 1 and 5)

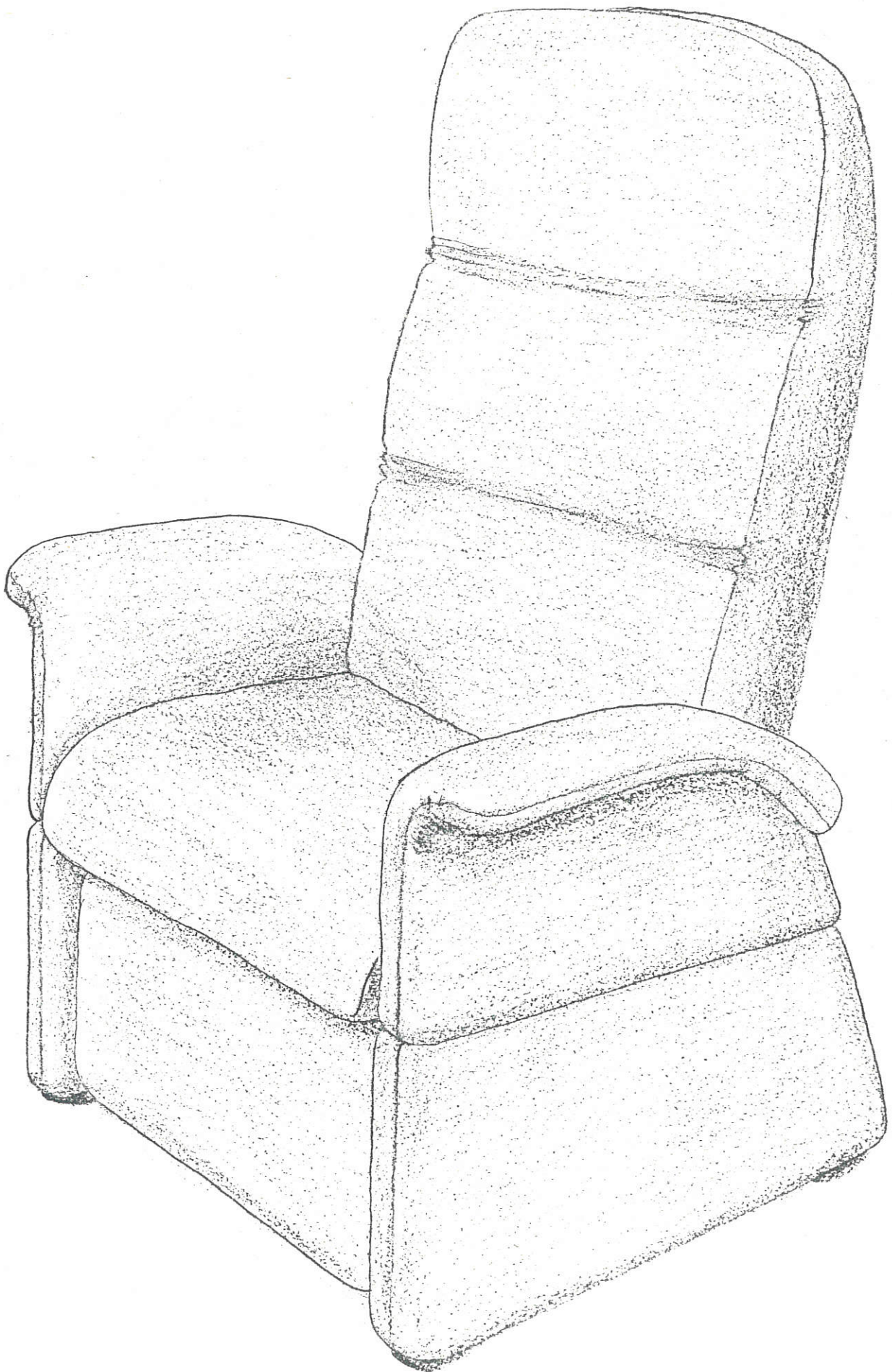



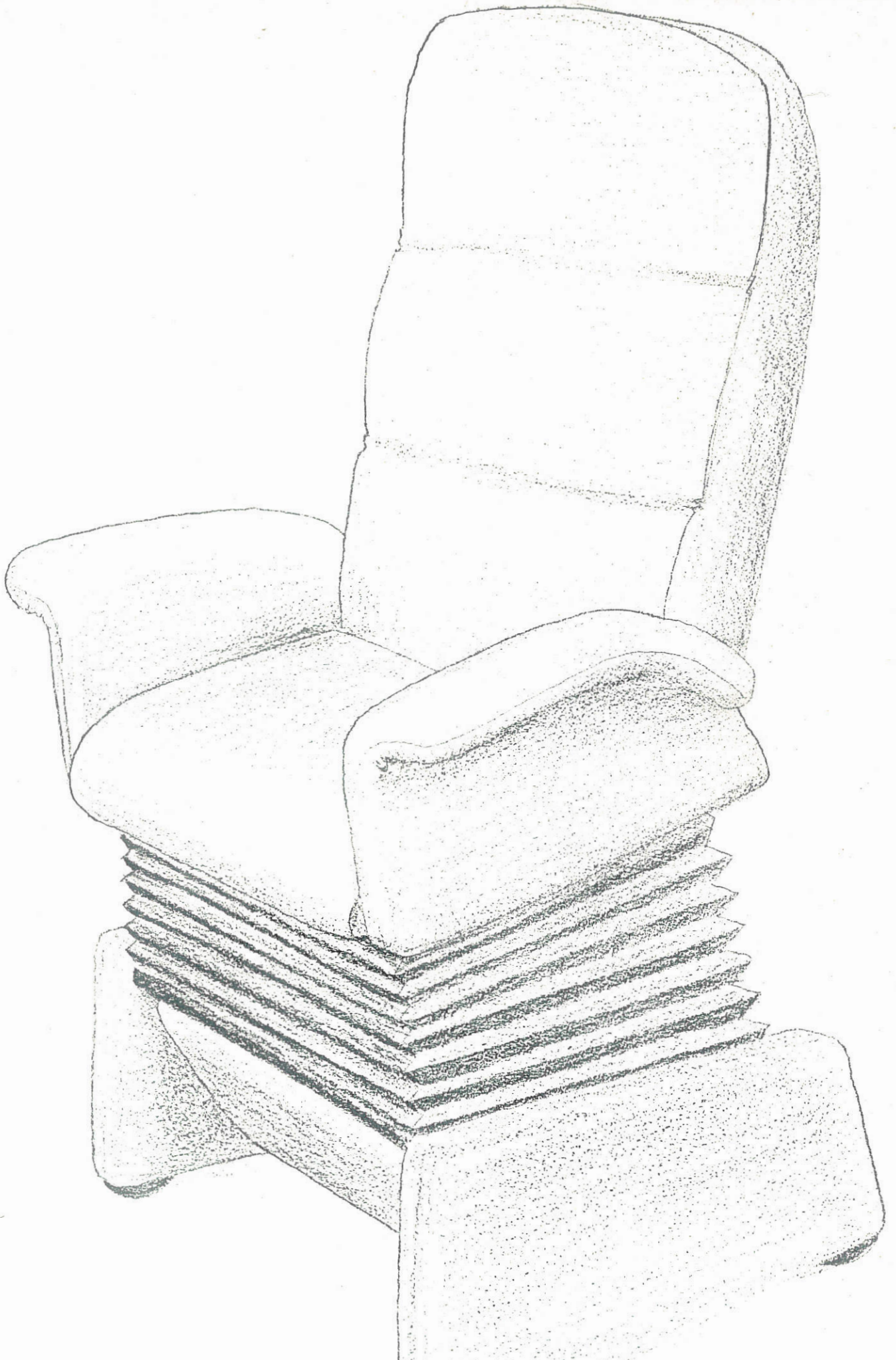







Area 1 Mr David Penney  
Miss Tracy Hunt  
Ext 244

tel: (040486) 587

Avon  
Cornwall  
Devon  
Dorset (*excluding Boscombe, Bournemouth,  
Christchurch, Ferndown, Poole, Swanage, Wareham,  
Wimborne*)  
Somerset  
Wiltshire

Area 2 Mr Harry Jones  
~~Mrs Trish Chilton~~  
Ext 292

MR MARION  
LARKIN

tel: (0705) 469001

Berkshire  
Bucks: *Burnham only*  
Channel Islands (*Jersey, Guernsey*)  
Dorset (*Boscombe, Bournemouth, Christchurch, Ferndown,  
Poole, Swanage, Wareham, Wimborne only*)  
Hampshire  
Isle of Wight  
Middlesex: *Staines only*  
Surrey: *Ash Vale, Camberley, Chertsey, Cranleigh, Egham,  
Farnham, Godalming, Guildford, Haslemere,  
Hinehead, Woking.*  
West Sussex

Area 3 Mr Nigel Booth  
Mrs Val Buckingham  
Ext 291

(0233) 628268

Kent  
London (*South of Thames, ie SE1-SE26, SW2/4/8/9/11-20*)  
Surrey: *Addlestone, Ashted, Banstead, Carshalton, Caterham,  
Cheam, Chessington, Claygate, Cobham, Coulsdon,  
Croydon, Dorking, Dormansland, Epsom, Fetcham, Ham,  
Horley, Kew, Kingston, Leatherhead, Lingfield, Morden,  
New Malden, Oxted, Petersham, Purley, Redhill, Reigate,  
Richmond, Sanderstead, Selsdon, Surbiton, Sutton,  
Wallington, Walton-on-Thames, Weybridge,  
Worcester Park.*  
East Sussex

Area 7 Mr Hedley Wright  
~~Mrs Doreen Jacks~~  
Ext 236

Sarah  
TURNER

(04493) 7942

Bedfordshire  
Cambridgeshire  
Essex  
Hertfordshire (*East of M1, ie excluding Berkhamsted,  
Chorley Wood, Croxley Green, Tring, Watford*)  
London (*North of Thames and East of River Lea, ie  
E4/6/7/10-13/15-18 only*)  
Norfolk  
Suffolk

Area 8 Mr Jon Goodwin  
Mrs Doreen Newell  
Ext 213

(0734) 482439

Buckinghamshire (*except Burnham*)  
Hertfordshire (*West of M1, ie Berkhamsted, Chorley Wood,  
Croxy Green, Tring, Watford only*)  
London (*North of Thames and West of River Lea, ie  
N, NW, W, WC, EC, SW1/3/5/6/7/10, E1/2/3/5/8/9/14*)  
Middlesex (*except Staines*)  
Northamptonshire  
Oxfordshire



Area 9 Mr Haydn Gabb  
Miss Kelly Brown  
Ext 203

(0633) 420369

Gloucestershire  
Hereford & Worcester  
Shropshire  
Wales (Mid & South except Machynlleth) (*ie Dyfed, Glamorgan, Gwent, Powys*)  
Warwickshire (*except North of M6, ie except Atherstone, Bedworth*)  
West Midlands (*West of M5/6, ie Brierley Hill, Dudley, Halesowen, Wednesbury, Wolverhampton only*)  
Worcestershire

Area 10 Mr Mark Lambert  
SARA H TURNER ~~Miss Paula Robinson~~  
~~Ext 239 GA 226~~

(0533) 703512

Derbyshire (*except Buxton, Glossop, Whaley Bridge*)  
Leicestershire  
Lincolnshire (*except Gainsborough, Louth, Market Rasen*)  
Nottinghamshire  
Staffordshire  
West Midlands (*Except Brierley Hill, Dudley, Halesowen Wednesbury and Wolverhampton*)  
Warwickshire (*North of M6 only, ie Atherstone, Bedworth Nuneaton only*)

Area 12 Mr N Beesley  
Miss Sarah Turner  
Ext 293

Trish Callaghan

(0226) 764312

Cheshire (*South of A55/56, ie all except Chester, Ellesmere Port, Helsby, Runcorn, Warrington, Widnes*)  
Derbyshire (*Buxton, Glossop, Whaley Bridge only*)  
Humberside (*N & S*)  
Lincolnshire (*Northern strip only, including Gainsborough, Louth and Market Rasen*)  
Gtr Manchester (*Altrincham, Bramhall, Cheadle, Cheadle Hulme, Gatley, Hazel Grove, Hyde, Marple, Stockport only*)  
Yorkshire, E N & W (*except Hawes, Northallerton, Richmond Settle, Whitby*)

Area 13 Mr Neil Donbavand  
Miss Kelly Brown  
Ext 203

061-445-2168

Cheshire (*N of A55/6, ie Chester, Ellesmere Port, Helsby, Runcorn, Warrington, Widnes only*)  
Lancashire (*except Barrow in Furness, Blackpool, Cleveleys, Fleetwood, Grange-over-Sands, Lancaster, Lytham, Morecombe, Poulton Le Fylde*)  
Gtr Manchester (*except Altrincham, Bramhall, Cheadle, Cheadle Hulme, Gatley, Hazel Grove, Hyde, Marple, Stockport*)  
Merseyside  
North Wales (*i.e. Clwyd, Gwynedd*)

Area 14 Mr Phil Clark  
Miss Paula Robinson  
Ext 239

091 251 1506

Cleveland  
Cumbria  
Durham  
Lancashire (*Barrow in Furness, Blackpool, Cleveleys, Fleetwood, Grange-over-Sands, Lancaster, Lytham, Morecombe, Poulton Le Fylde only*)  
Northumberland  
Scotland - border areas (*ie Berwickshire, Dumfries, Kirkcudbrightshire, Roxburghshire, Selkirk, Wigtown*)  
Tyne & Wear  
N Yorks (*Northallerton, Richmond, Settle, Whitby Hawes only*)

Area 15 Mr Harold Brown Isle of Man  
Mrs Pat Tinnelly Northern Ireland  
Ext 241  
*(0247) 472698*

Area 16 Mr Ken Crozier Scotland (excluding border areas, ie excluding Berwickshire,  
Mrs Pat Tinnelly Dumfries, Kirkcudbrightshire, Roxburghshire, Selkirk,  
Ext 241 *(03502) 8885* *Wigtown*)

Area 94 Mr Dermot Delaney Eire  
~~Mrs Jackie Glenister~~  
Ext 246 *Phyl Wilson Dublin 589101*

Export Mrs Jackie Glenister Export  
Ext 246

*JOHN LEWIS BRANCHES: PAULA ROBINSON EXT. 239*

NB: EXCEPTIONS

Harrods .....	Mrs Doreen Newell	Ext 213
Chipping Norton Showrooms .....	<del>Mrs Val Buckingham</del>	<del>Ext 291</del>
Directors Accounts .....	Mrs Val Buckingham	Ext 291
Gift Account, Ken Crook .....	Mrs Val Buckingham	Ext 291
London Showrooms .....	Mrs Val Buckingham	Ext 291
Photography Account .....	Mrs Val Buckingham	Ext 291
Staff Sales .....	Mrs Val Buckingham	Ext 291
Showcase Window Account, High Wycombe.....	Mrs Val Buckingham	Ext 291

Retail Sales Office Manager .....	Mr Graham Haines	Ext 248
Retail Sales Manager .....	<del>Mr Ted Pick</del> <i>AJB</i>	Ext 265
Secretary to Sales Manager .....	<i>TRISH CHILTON</i>	Ext 264
Retail Sales Secretary .....	Miss Karen Grange	Ext 264
	Mrs Jenny Morris	Ext 248



RETAIL REPRESENTATIVES

Mr N Beesley  
11 Wordsworth Avenue  
Penistone  
Sheffield  
S30 6EX

(0226) 764312

Mr N Booth  
12 Ash Close  
Ashford  
Kent  
TN23 3JU

0233 628268

Mr H Brown  
3 The Maples  
Bangor  
Co Down  
N Ireland  
BT19 2XY

(0247) 472698

Mr P Clark  
5 Northcote Avenue  
Monkseaton  
Whitley Bay  
Tyne & Wear  
NE25 8ER

091 2511506

Mr K Crozier  
'Balmore'  
Perth Road  
Birnam  
Dunkeld  
Perthshire  
PH8 0BH

Dunkeld(03502) 8885

Mr T N Donbavand  
377 Parrs Wood Road  
Didsbury  
Manchester  
M20 1JQ

061 445 2168

Mr H Gabb  
Poplar Cottage  
Llanhennock  
Nr Caerleon  
Newport  
Gwent  
NP6 1LU

(0633) 420369

Mr H T Jones  
16 North Shore Road  
Hayling Island  
Hants  
PO11 0HL

(0705) 469001

Mr J Goodwin  
279 Gosbrook Road  
Reading  
RG4 8DX

0734 482439

Mr M A Lambert  
'Meersbrook'  
6 School Walk  
Kibworth  
Leics  
LE8 0JB

0533 793512

Mr D Penney  
Newcott Cottage  
Yarcombe  
Nr Honiton  
Devon  
EX14 9ND

Uppottery 040486 587

Mr H Wright  
9 Meadow Close  
Felsham  
Bury St Edmunds  
Suffolk  
IP30 1QS

(04493) 7942

RETAIL AGENT

Mr D Delaney  
50 Beechwood Lawns  
Rathcoole  
Co Dublin  
Eire

Dublin 589101

# Parker Care

## PARKER CARE LIST OF STOCKISTS/DISTRIBUTORS

NAME	ADDRESS	TELE.NO
G.D. FAIRBARN LIMITED,	14-24 Church Street, BERWICK-ON-TWEED, TD15 1DY	0289-306177
KEEPABLE CENTRE,	2 Capital Interchange Way, BRENTFORD, TW8 0EX	081-742-2181
HORIZON FURNITURE,	Unit 2, Level Street, BRIERLEY HILL, West Midlands	0383 262200
JOHNS OF CAMBRIDGE LTD,	297 Histon Road, CAMBRIDGE, CB4 3JT	0223 359476
DISABLED CARE AND MOBILITY,	Unit 1, Katherine Salisbury Avenue, Warden Hill, CHELTENHAM, GLOS.	2042 262044
EDGAR MALTBY,	90/94 Brooke Street, CHESTER, CHESHIRE, CH1 3DH	0244 324560
REGENT UPHOLSTERY,	87 Frinton Road, Holland-on-Sea, CHACTON, Essex CO15 5UH	0255 813551
COVENTRY BACK CARE SHOP,	23 Clay Lane, COVENTRY, CV2 41J	0203 455555
MOBILITY WALES LIMITED,	4 High Street, COWBRIDGE, South Glamorgan	0446 773393
DAVID MANN & SONS LTD,	High Street, CRANLEIGH, Surrey GU6 8AY	0483 273777
ATWELL DEAN ASSOCIATES,	165 Shirley Road, CROYDON, CRO 8SS	081 656 4627
REGENCY FINE FURNISHINGS,	29 Larchfield Street, DARLINGTON, Co. Durham	0325 467091
JAMES CAINE LIMITED,	Desmene Road, DOUGLAS, Isle of Man	0624 74558
BARRMED,	Clifton House, Lower Fitzwilliam Street, DUBLIN 2, Eire	0001 838453
M.PATTISON & CO LIMITED,	16/17 Elvet Bridge, DURHAM, Co. Durham	091 386 4618
PETER ADAMS (WATFORD) LIMITED	208 Station Road, Edgeware, Middlesex HA8 7AR	081 958 3155
BACK WORLD,	202 Topsham Road, EXETER, Devon	0392 430107



FELGAINS,	36-38 Gainsborough Road, <b>FELIXSTOWE</b> , Suffolk IP11 7HR	0394 286881
R.KINCAID & CO,	646 Argyle Street, <b>GLASGOW</b> , Scotland	041 248 6472
Wm FLORENCE FURNISHERS LIMITED,	Ashmount Mills, <b>HAWORTH</b> , W.Yorks	0535 44730
OLIVER & SON LIMITED,	11 Coinagehall Street, <b>HELSTON</b> , Cornwall, TR13 8ER	0326 572082
HULL LOOSLEY & PEARCE LIMITED,	120 Oxford Road, <b>HIGH WYCOMBE</b> , Bucks	0494 33222
GIBBINS HOUSE FURNITURE LIMITED,	364-366 Bath Road, <b>HOUNSLOW</b> , Middx	081 572 5209
VOISIN & CO,	Kings Street, <b>ST.HELIER</b> , <b>JERSEY</b> , Channel Islands	0534 70511
DRAPERS FURNISHERS,	57 Montague Street, <b>KETTERING</b> , Northants	0536 514195
DONOVAN & SON LIMITED.	49 Fore Street, <b>KINGSBRIDGE</b> , S.Devon	0548 2342
YORKSHIRE CARE EQUIPMENT,	6 Over Lane, Rawdon, <b>LEEDS</b> , LS19 6DY	0532 503977
UPPERTON FURNISHINGS,	6/12 Hinckley Road, <b>LEICESTER</b> , Leics	0533 541832
EASI-WAY CENTRE,	33-37 Grange Road West, Birkenhead, <b>LIVERPOOL</b> , L43 4BY	051 6085093
WATERLOO FURNISHING LIMITED,	47/53 South Road, Waterloo, <b>LIVERPOOL</b> , LE22 5PE	051 920 9388
BRYANT & HOCKNELL LIMITED,	21 Gloddaeth Street, <b>LLANDUDNO</b> , LL30 2DG	0492 75923
GREENWOOD FURNITURE CO.LIMITED,	386 Bowes Road, Arnos Grove, <b>LONDON</b> N11 1AB	081 368 0281
W.G.HART,	129 Lower Clapton Road, Hackney, <b>LONDON</b> E5 ONP	081 985 3934
ARIGHI BIANCHI & CO.LIMITED,	Commercial Road, <b>MACCLESFIELD</b> , Cheshire	0625 27293

H.KENNEDY & CO.LIMITED,	50/56 Rainey Street, <b>MAGHERAFELT</b> , CO.Londonderry, N.Ireland	0648 32427
NURSING AIDS & APPLIANCE CENTRE,	North East House, 62 Oakhill Trading Estate, Walkden, <b>MANCHESTER</b> .	0204 709255
WHITEHEADS,	36 Regent Road, <b>MORECAMBE</b> , Lancs	0524 413174
J.C.PEACOCK & SON LIMITED,	Friar House, Clavering Place, <b>NEWCASTLE-UPON-TYNE</b> .	091 2329917
BARKERS,	198/202 High Street, <b>NORTHALLERTON</b> , N.Yorks	0609 772303
COLLINS CARE,	2 Sprowston Road, <b>NORWICH</b> , NR2 1NA	0603 414294
THE MOBILITY AIDS CENTRE,	88D South Street, Stanground, <b>PETERBOROUGH</b> , PE2 8EZ	0733 34493
RICHARD BAMBER & SON LIMITED,	102/104 Friargate, <b>PRESTON</b> , Lancs	0772 54480
BUSWELLS,	120 Elm Grove, Southsea, <b>PORTSMOUTH</b> , Hants.	0705 823023
THE COMFORT SHOP,	17 Alexandria Drive, <b>ST.ANNES</b> , FY8 1JF	0253 724902
HANDICAPPED LIVING CENTRE,	69-71 The Wicker, <b>SHEFFIELD</b> , S3 8HT	0742 723729
H.PONSFORD LIMITED,	579-601 London Road, <b>SHEFFIELD</b> , S2 4HS	0742 550075
J.H.JONES,	51-52 Mardol, <b>SHREWSBURY</b> , Shropshire	0743 62097
T.R.HIGHTON LIMITED,	129-131 Lord Street, <b>SOUTHPORT</b> , Lancs	0704 535593
ALDRED BRASS LIMITED,	Regency House, 16 Waterloo Place, <b>SUNDERLAND</b> , Tyne & Wear	091 567 2936
DOMESTIC & MEDICAL AIDS,	Unit 7, Apple Business Centre, Frobisher Way, Bindon Road, <b>TAUNTON</b> , Somerset.	0823 335505
JAMES BRITTEN & SON,	4b Bold Street, <b>WARRINGTON</b> , Lancs	0925 35734



THE CHAIR SHOP,	187 Park View, <b>WHITLEY BAY,</b> Tyne & Wear	091 297 0477
ABBOTT & SMITH LIMITED.	735/7 Ormskirk Road, Pemberton, <b>WIGAN,</b> Lancs	0942 214871
LARNERS (WITNEY) LIMITED,	62-66 High Street, <b>WITNEY</b> Oxon	0993 702385
H.G.SCADGELL LIMITED,	106/110 Montague Street, <b>WORTHING,</b> W.SUSSEX	0903 34811

Rep. 1 - David Penney:

Calverts, Taunton

Denners, Yeovil

Donovans, Kingsbridge\*

Harper, Bath

Oliver & Son\*

Potbury, Sidmouth

Southon, Salisbury

Way, Bideford\*

Challicoms, Clevedon

\*Parker Care Accounts which have done business in last financial year.



Rep. 2 - Harry Jones

Buswells, Southsea\*

Coombes, Aldershot

Habel, Winchester\*

Hills, Ryde, I.O.W.

Keith Jay, Bognor Regis

Reynolds, Bognor

Thaw, Burgess Hill

Voisins, Jersey\*

\*Parker Care Accounts which have done business in last financial year

Rep. 3 - Nigel Booth

Lenleys, Canterbury

Lyn Plan, Croydon

Perrings, Eastbourne

Weekes, Tunbridge Wells\*

\*Parker Care Accounts which have done business in last financial year.



Rep. 7 - Hedley Wright

W J Aldiss, Fakenham

Eaden Lilley, Cambridge

Hatfield, Colchester

Hatters, Bedford

Marshalwick, St. Albans

Philpotts, Hitchin

Regent, Clacton

West, Southend

Rep. 8 - Jon Goodwin

Gibbins, Hounslow

Harts, Hackney, E5\*

Hull Loosley & Pearce, High Wycombe\*

Larners, Witney

Perrings, North Finchley

Drapers, Kettering\*

\*Parker Care accounts which have done business in last financial year.



Rep. 9 - Haydn Gabb

Grafton House, Evesham

Horizon, Brierley Hill\*

Jenkins, Swansea

Jones, Shrewsbury\*

M A Jones, Cardiff\*

Staites, Gloucester

Westmede, Warwick

Worcester Furn. Exhibition Centre

\*Parker Care accounts who have done business in last financial year.

Rep. 10 - Mark Lambert

Baines (now HOUSE OF SHAH), Lincoln

By-Rite, Stoke on Trent

Cooke, Birmingham

Stuart Edwards, Bedworth\*

Gold & Dunn, Nottingham\*

Charles Smith, Solihull

Uppertons, Leicester\*

\*Parker Care accounts which have done business in last financial year

Rep. 12 - Nigel Beesley

Arighi Bianchi, Macclesfield

Florence, Haworth

Chanterlands, Hull

Kettleys, Yeadon, Leeds

Goodwin T/A Ledgard & Wyn, Skipton

Lees, Grimsby

Ponsford, Sheffield

Pratt, Bradford

Shofields, Leeds

Ward, Doncaster



Rep. 13 - Neil Donbavand

Highton, Southport

Partington, Sale\*

Tasker, Accrington

Williams, Llangefni

Waterloo Furnishers, Liverpool\*

\*Parker Care accounts which have done business in last financial year.

Rep. 14 - Phil Clark

Barkers, Northallerton

Chapman, Carlisle

Chapman, Newcastle-upon-Tyne

Dayton House, Blackpool

Norman Fidler, Newton Stewart

Musgroves (NOW J R TAYLOR, Kendal

Newgate Furnishers, Newcastle (THIS BRANCH CLOSED NOW AT WHITLEY BAY)

Regency, Darlington\*

Whittakers, Lancaster

\*Parker Care accounts which have done business in last financial year.

Rep. 15 - Harold Brown

James Caine, Douglas, Isle of Man

Patterson, Co. Antrim, N.Ireland

Shiels, Strabane, N.Ireland



Rep. 16 - Ken Crozier

Anderson & England, Elgin

Archibald, Aberdeen

Broomlands, Largs\*

Cameron, Perth

Castle Warehouses, Peebles

Forrest Furnishing, Glasgow

Lorimer & Beetham, Edinburgh

Maitland, Fraserburgh

Maitland, Turriff

Martin & Frost, Edinburgh

Martin & Frost, Glasgow

Martin & Frost, Inverness\*

Mason Murphy, Kilmarnock

Robertson, Dundee\*

\*Parker Care accounts which have done business in last financial year

last-PC

LIST OF PARKER CARE CENTRES

- 7 W J Aldiss, Fakenham
- 16 Anderson & England, Elgin
- 12 Arighi Bianchi, Macclesfield
- 16 Archibald, Aberdeen
- 12 Florence, Haworth
- 10 ~~Baines~~, Lincoln
- 14 Barkers, Northallerton
- 16 Broomlands, Largs *current A/c.*
- 16 Buswells, Southsea *Current A/c have done business in last fin. yr.*
- 2 Burrell, Chester *+ A/c Closed*
- 10 By-Rite Stoke on Trent
- 1 Calverts, Taunton
- 16 Cameron, Perth
- 12 Chanterlands, Hull
- 14 Chapman, Carlisle
- 14 Chapman, Newcastle upon Tyne
- 2 Chapmans, Banbury *closed*
- 2 Coombes, Aldershot
- 14 Dayton House, Blackpool
- 1 Denners, Yeovil
- 1 Donavons, Kingsbridge *current A/c.*
- 7 Eaden Lilley, Cambridge
- 10 Stuart Edwards, Bedworth *current A/c.*
- 16 Forrest Furnishing, Glasgow
- 8 Gibbins, Hounslow
- 3 Grafton House, Evesham
- 10 Gold & Dunn Nottm *current*
- 2 Habel, Winchester *current A/c.*
- 1 Harper, Bath
- 8 Harts, Hackney, E5 *current.*
- 7 Hatfields, Colchester
- 7 Hatters, Bedford
- 2 Hills, Ryde IOW
- 13 Highton Southport
- 9 Horizon, Brierley Hill *current.*
- 18 Hull Loosley & Pearce High Wycombe *current A/c.*
- 2 Isaacs, Slough *A/c Closed*
- 2 Keith Jay, Bognor Regis
- 9 Jones, Shrewbury *current A/c.*
- 9 M A Jones, Cardiff *current A/c.*
- 12 Kettleys, Yeadon *(nr Leeds)*
- 8 Larners Witney
- 12 Ledward & Wyn, Skipton *(Goodwin T/A Low-A/c: GO2010)*
- 12 Lees, Grimsby
- 3 Lenleys, Canterbury
- 16 Lorimer & Beetham, Edinburgh
- 3 Lyn Plan, Croydon
- 16 Maitland, Fraserburgh
- 16 Maitland, Turriff
- 2 David Mann, Cranleigh *Survey*
- 7 Marshalwick, St Albans
- 16 Martin & Frost, Edinburgh
- 16 Martin & Frost, Glasgow *Business - current A/c.*
- 16 Mason Murphy, Kilmarnock
- 2 Meads, Westbourne *now T/A Wenders A/c WE 2012007*
- 13 Mears, Preston *+ A/c Closed*
- 14 Musgroves, Kendal *W R Taylor nu 0218.*
- 14 Nelson, Sunderland *A/c closed*
- 14 Newgate Furn., Newcastle *Whitley Bay?*  
*moved to.*  
*NE 0502.*